

Epsilon Range

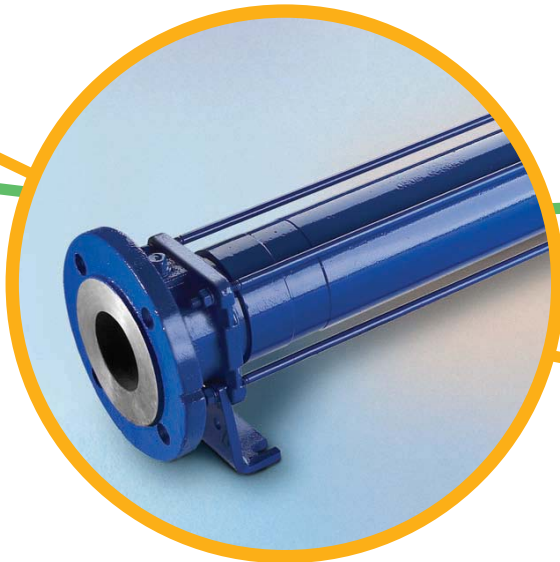

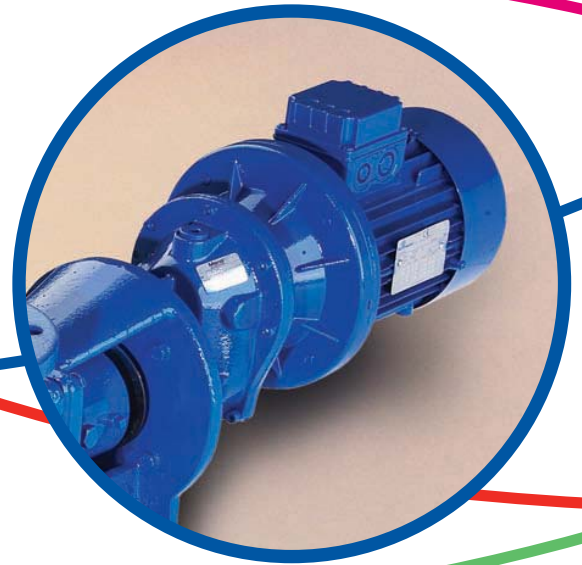
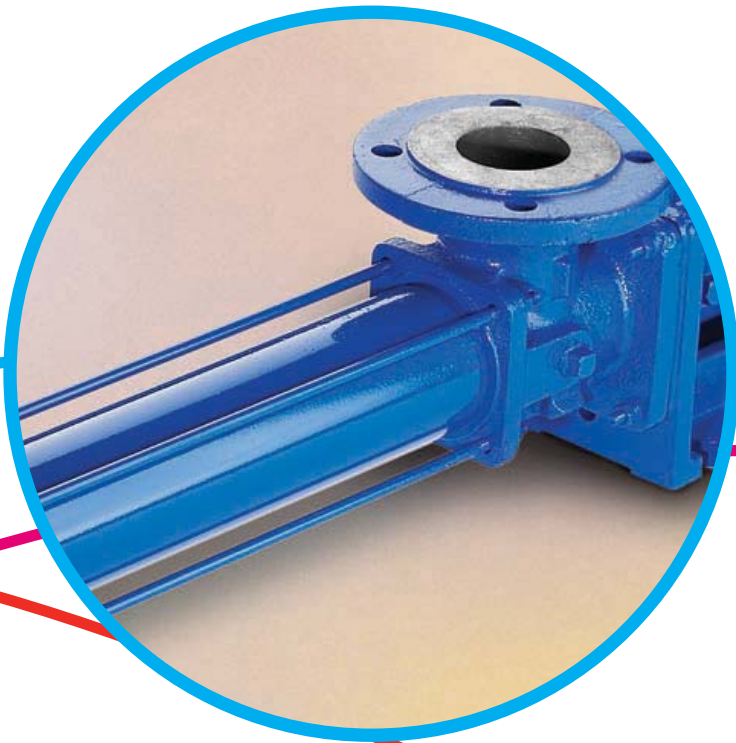
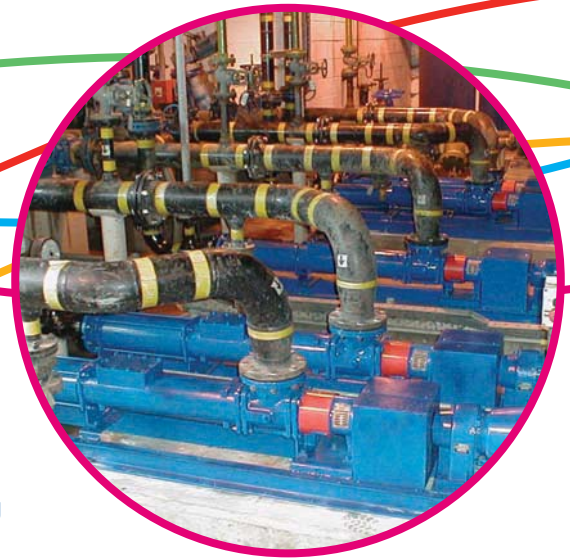

Sludge pumping

Features & Benefits

Capacity	up to 420m ³ /h
Pressure	up to 24 bar
Temperature	-10°C up to 110°C

Typical applications include:

- Primary and secondary sludges
- Domestic and industrial effluents
- Hydrated lime slurry
- Dewatered sludge cake
- Shear sensitive latex emulsion
- Milk curds, sauces, fruit juices
- Crude oil, hydraulic oil, waste oil
- Industrial chemicals and detergents
- Starch slurries
- Coating clays, gypsum and silicate
- Paper stocks
- Agricultural slurries
- Mine de-watering

“A range of technically engineered progressing cavity pumps, designed to give least whole life costs and reduced spares requirements.”

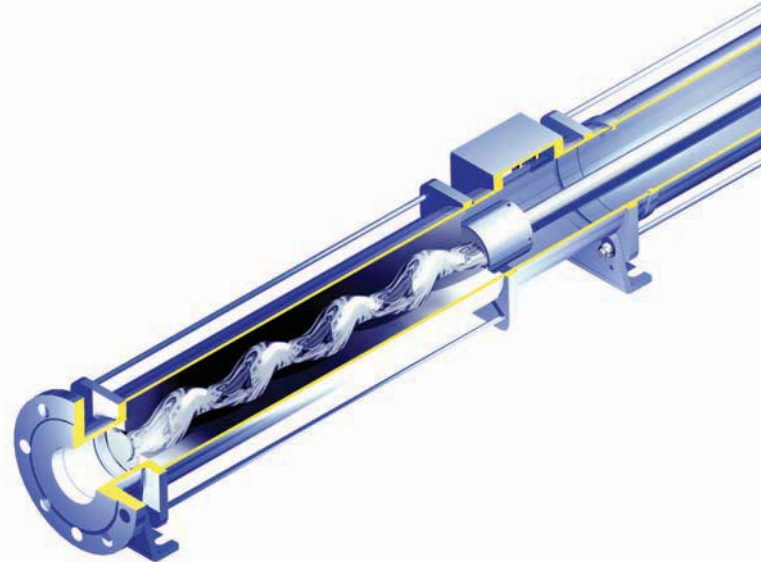

Materials of construction

Available in cast iron or stainless steel, with a choice of rotor and stator materials to suit individual applications e.g. hard chrome plated rotor or natural rubber stator.

High pressure / long haul pumping

Can offer considerable project cost savings by utilising small bore pipework and eliminating the need for a series of pumps, when pumping over long distances or with high head requirements.

Low running speeds

Reduced wear for a longer working pump life which extends the periods between routine maintenance. Think of the savings you could make on abrasive applications.



Transfer of raw sewage from a domestic installation

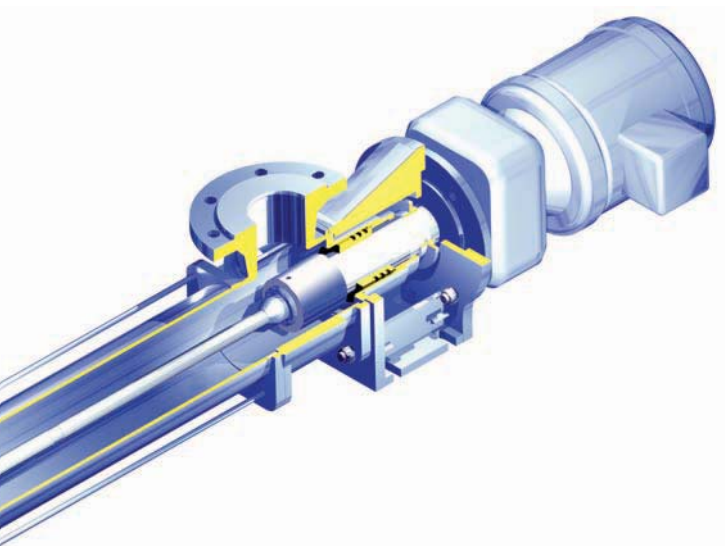

Drive shaft connection

The Flexishaft® eliminates wearing components between the drive end and the pumping element. No lubrication is needed, therefore product contamination is eliminated.

A shorter Flexishaft is available where space saving is a priority.

Mono's Flexishaft is backed by a 10 year warranty.

Versatile

Can be installed vertically or horizontally to suit the application. Can be run in either direction.

Robust drives

Specially selected fixed and variable speed drives for longer life, due to flange mounted drive.

Bloc construction

Minimises overall dimensions, giving you a shorter pump length. Eliminates the need for coupling and guard.

Interchangeable components

A large number of Epsilon components are interchangeable with the Compact C Range, reducing inventory holding.

Baseplate

Low cost, form folded baseplate.

Inspection cover

Available for applications where rag content is a problem.

Gentle pumping action

Minimises shear and crush damage to the pumped product and maintains a steady flow when pumping products with a high solids content.

Duracoat coating

Rotors can be supplied with Mono's range of specialist coatings to help extend the life of the rotors by increasing wear and corrosion resistance.

Up to 8.5m suction lift

Deep sumps can be easily emptied without the use of submersible equipment.

Plug in shaft

Ease of maintenance when assembling or dismantling, with extraction facility.

Shaft sealing options

Single seal supplied as standard, packed gland or double mechanical seals are available.

Handles gas entrainment

No air or gas locking in the pump. The positive seal formed by the interference fit between rotor and stator enables the pump to self prime and it also allows tri-phase liquids i.e. solids, gases and liquids to be handled easily.

Pumping
glaze/water
from holding tanks

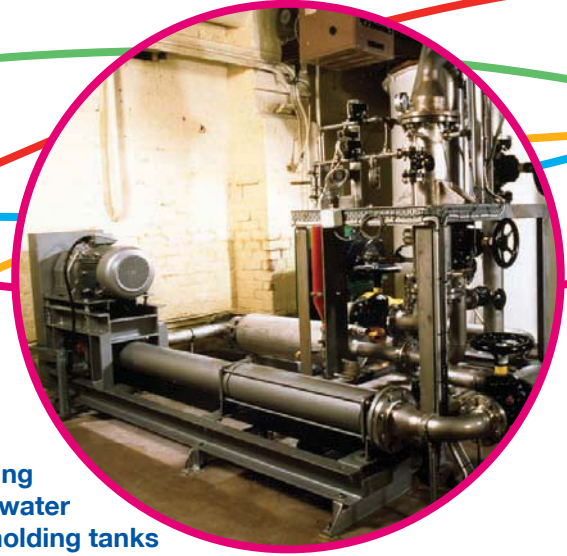

Performance Data

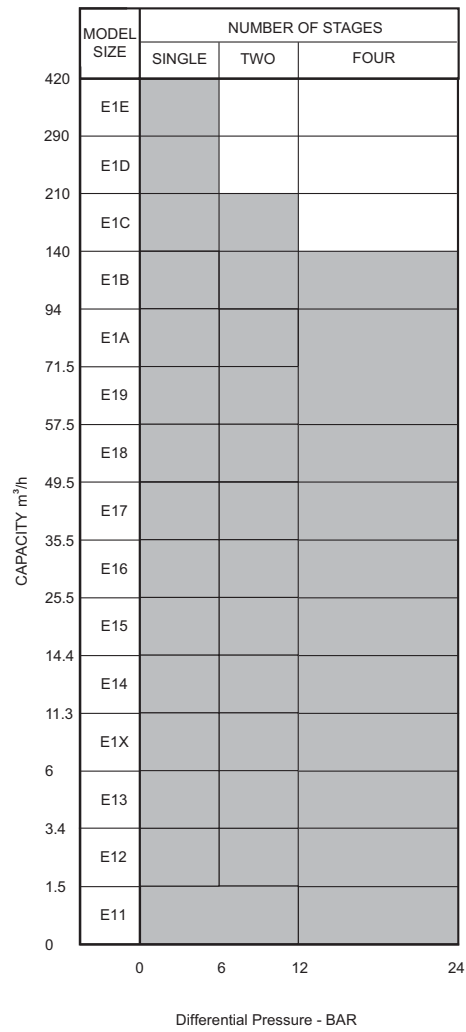
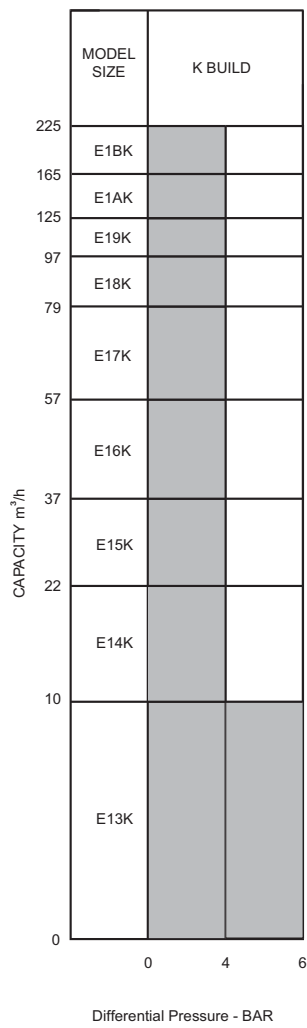

For guidance in selecting a pump, please contact Mono.



Transfer of hydraulic/
waste oil

Product Dimensions

Small Epsilon Models - Standard Flexishaft

MODEL	A	A1	B	C	D	E	F	G	H
E11B	577	105	444	133	1 1/4"	146	85	120	160
E11D	721	115	588	133	1 1/4"	146	85	120	160
E12A	577	105	444	133	1 1/4"	146	85	120	160
E12B	721	115	588	133	1 1/4"	146	85	120	160
E12D	1081	115	944	137	1 1/2"	146	85	120	160
E13K	787	90	650	137	1 1/2"	146	85	120	160
E13A	642	90	505	137	1 1/2"	146	85	120	160
E13B	787	90	650	137	1 1/2"	146	85	120	160
E1XA	726	115	569	157	50	190	85	120	160
E1XB	1016	115	786	230	65	227	112	140	200

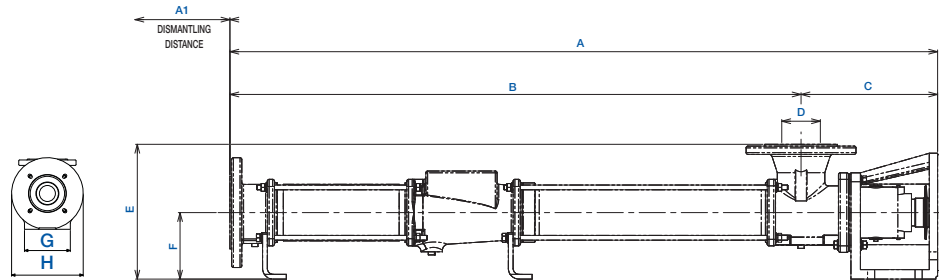
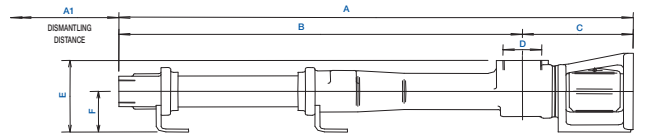

Standard Flexishaft Models

MODEL	A	A1	B	C	D	E	F	G	H
E14A	1190	250	960	230	65	227	112	140	200
E14B	1507	455	1277	230	65	227	112	140	200
E14K	1395	455	1165	230	65	227	112	140	200
E15A	1363	310	1143	220	80	232	112	140	200
E15B	1823	570	1546	277	80	245	125	160	250
E15K	1623	570	1403	220	80	232	112	140	200
E16A	1625	365	1389	236	100	255	125	160	250
E16B	2179	680	1860	319	100	280	150	180	300
E16K	1937	680	1701	236	100	255	125	160	250
E17A	1934	430	1654	280	125	310	150	180	300
E17B	2389	800	2109	280	125	310	150	180	300
E17K	2302	800	2022	280	125	310	150	180	300
E18A	2064	475	1784	281	125	310	150	180	300
E18B	2745	880	2377	368	125	320	160	200	300
E18K	2472	880	2192	280	125	310	150	180	300
E19A	2395	530	2080	315	150	345	160	200	300
E19B	2857	990	2542	315	150	345	160	200	300
E19K	2857	990	2542	315	150	345	160	200	300
E1AA	2628	610	2313	315	150	345	160	200	300
E1AB	3330	1100	2927	403	150	410	225	280	350
E1AK	3159	1100	2844	315	150	345	160	200	300
E1BA	3048	640	2620	428	200	450	225	280	350
E1BK	3602	1210	3174	428	200	450	225	280	350

Short Flexishaft Models

MODEL	A	A1	B	C	D	E	F	G	H
E14A	980	250	750	230	65	227	112	140	200
E14B	1297	455	1067	230	65	227	112	140	200
E14K	1185	455	955	230	65	227	112	140	200
E15A	1153	310	933	220	80	232	112	140	200
E15B	1597	570	1320	277	80	245	125	160	250
E15K	1413	570	1193	220	80	232	112	140	200
E16A	1399	365	1163	236	100	255	125	160	250
E16B	1860	680	1541	319	100	280	150	180	300
E16K	1711	680	1475	236	100	255	125	160	250
E17A	1615	430	1335	280	125	310	150	180	300
E17B	2077	800	1797	280	125	310	150	180	300
E17K	1983	800	1703	280	125	310	150	180	300
E18A	1752	475	1472	280	125	310	150	180	300
E18B	2359	880	1991	368	125	320	160	200	300
E18K	2160	880	1880	280	125	310	150	180	300
E19A	2010	530	1695	315	150	345	160	200	300
E19B	2472	990	2157	315	150	345	160	200	300
E19K	2472	990	2151	315	150	345	160	200	300
E1AA	2238	610	1923	315	150	345	160	200	300
E1AB	2993	1100	2590	403	150	410	225	280	350
E1AK	2769	1100	2454	315	150	345	160	200	300
E1BA	2661	640	2233	428	200	450	225	280	350
E1BK	3266	1210	2838	428	200	450	225	280	350

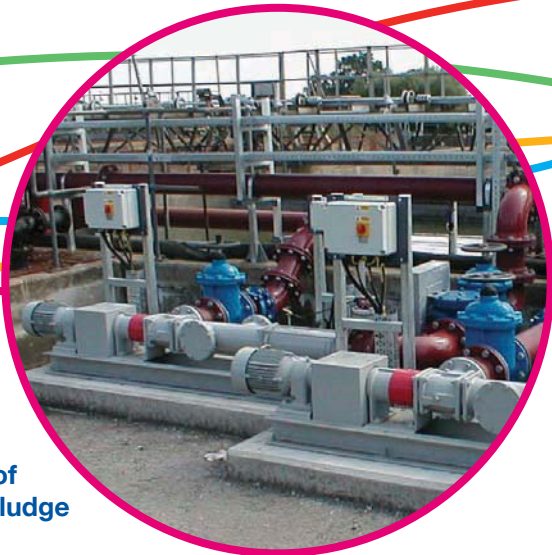

Transfer of primary sludge

Product Dimensions

4 Stage Models - Standard Flexishaft

MODEL	A	A1	B	C	D	E	F
E13D	1365	230	1035	330	50	205	100
E1XD	1796	255	1411	385	65	227	112
E14D	2090	780	1633	457	80	245	125
E15D	2596	1005	2065	531	100	280	150
E16D	3058	1210	2466	592	125	320	160
E17D	3554	1385	2825	729	125	385	225
E18D	3855	1555	3114	741	150	410	225

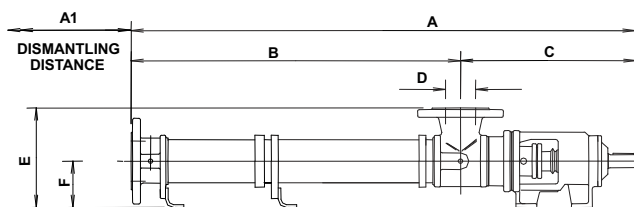

Large Epsilon Models - Standard Flexishaft

MODEL	A	A1	B	C	D	E	F
E1BB	4160	1235	3392	768	200	475	250
E1CA	4011	735	3203	808	250	500	250
E1CB	5485	735	4457	1028	300	620	330
E1DA	4312	1036	3504	808	250	500	250
E1EA	5777	735	4749	1028	300	620	330

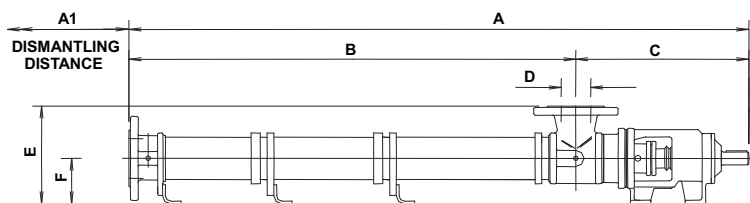

Large 4 Stage Epsilon Models Standard Flexishaft

MODEL	A	A1	B	C	D	E	F
E1AD	5129	1045	4360	769	200	465	250
E1BD	6156	1200	5158	998	200	610	330

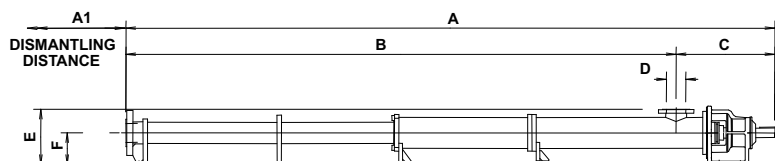



**Pumping
chemicals at
variable flows**

Motor/Baseplate Dimensions

SMALL EPSILON MODELS - STANDARD FLEXISHAFT

MODEL	LENGTH	WIDTH	HEIGHT
E11B	1132	300	304
E11D	1297	300	304
E12A	1132	300	304
E12B	1297	300	304
E12D	1666	300	304
E13K	1356	300	304
E13A	1206	300	304
E13B	1356	300	304
E1XA	1280	300	304
E1XB	1564	300	423

STANDARD FLEXISHAFT MODELS

MODEL	LENGTH	WIDTH	HEIGHT
E14A	1867	360	475
E14B	2188	420	475
E14K	2076	360	475
E15A	2040	360	475
E15B	2500	420	488
E15K	2300	420	475
E16A	2302	420	488
E16B	3167	520	609
E16K	2614	420	488
E17A	2893	420	584
E17B	3378	520	609
E17K	3291	520	609
E18A	3022	520	584
E18B	3788	520	649
E18K	3460	520	609
E19A	3443	520	649
E19B	3905	520	649
E19K	3905	520	649
E1AA	3676	625	649
E1AB	4378	520	727
E1AK	4207	520	649
E1BA	4101	520	727
E1BK	4653	520	727

SHORT FLEXISHAFT MODELS

MODEL	LENGTH	WIDTH	HEIGHT
E14A	1655	360	475
E14B	1975	420	475
E14K	1864	360	475
E15A	1827	360	475
E15B	2271	420	488
E15K	2087	420	475
E16A	2073	420	488
E16B	2847	520	609
E16K	2385	420	488
E17A	2573	420	584
E17B	3063	520	609
E17K	2931	520	609
E18A	3707	520	584
E18B	3401	520	649
E18K	3145	520	609
E19A	3056	520	649
E19B	3518	520	649
E19K	3518	520	649
E1AA	3282	625	649
E1AB	4037	520	727
E1AK	3813	520	649
E1BA	3713	520	727
E1BK	4312	520	727

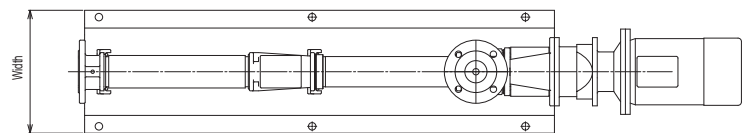
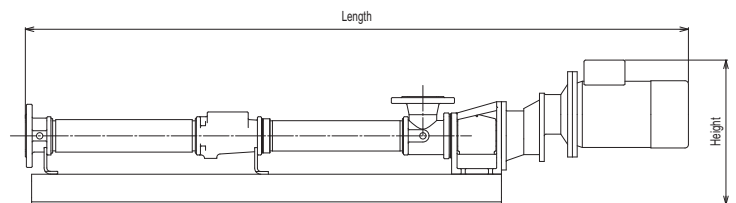

4 STAGE MODELS STANDARD FLEXISHAFT

MODEL	LENGTH	WIDTH	HEIGHT
E13D	1950	236	335
E14D	2552	372	479
E14D	2922	440	488
E15D	3614	473	552
E16D	4187	547	644
E17D	4737	578	700
E18D	5208	618	764
E1AD	6529	695	700
E1BD	7783	826	980

LARGE EPSILON MODELS STANDARD FLEXISHAFT

MODEL	LENGTH	WIDTH	HEIGHT
E1BB	5353	692	780
E1CA	4657	652	678
E1CB	7317	750	805
E1DA	5263	672	680
E1EA	7687	902	977

Europe

Mono Pumps Ltd, Martin Street, Audenshaw
Manchester, M34 5JA, England
T. +44 (0)161 339 9000
E. info@mono-pumps.com

D.M.I EST, 56, rue du Pont
88300 Rebeuville, France
T. +33 (0)3 29 94 26 88
E. dmi-est@dmi-est.fr

Americas

Monoflo NOV, 9700 West Gulf Bank
Houston, Texas 77040, USA
T. +1 281 272 7700
E. inquire@monoflo.com

Monoflo S.A., Ing Huergo 2239
(1842) Monte Grande
Pcia. de Buenos Aires, Argentina
T. +54 11 4290 9940/50
E. info@monoflo.com.ar

Monoflo Canada, 6010 - 53rd Ave
Alberta, Lloydminster
T9V2T2, Canada
T. +1 780 875 5584
E. info.monoflo@nov.com

Australasia

Mono Pumps (Australia) Pty Ltd
Mono House, 338-348 Lower Dandenong Road
Mordialloc, Victoria 3195, Australia
T. 1800 333 138
E. ozsales@mono-pumps.com

Mono Pumps (New Zealand) Ltd
PO Box 71-021, Fremlin Place, Avondale
Auckland 7, New Zealand
T. +64 (0)9 829 0333
E. info@mono-pumps.co.nz

Asia

Mono Pumps Ltd, No. 500 YaGang Road
Lujia Village, Malu, Jiading District
Shanghai 201801, P.R. China
T. +86 (0)21 5915 7168
E. monoshanghai@nov.com

www.mono-pumps.com



Published information other than that marked CERTIFIED does not extend any warranty or representation, expressed or implied, regarding these products. Any such warranties or other terms and conditions of sales and products shall be in accordance with Mono Pumps Limited standard terms and conditions of sale, available on request.

© Mono Pumps Limited June 2009 Literature reference: MP5B/03/01/R2
Mono® and Flexishaft® are registered trademarks of Mono Pumps Ltd.
Registered in England No 300721



One Company, Unlimited Solutions